

## Low power RS-485/RS-422 transceiver

### Features

- Low quiescent current: 300  $\mu$ A
- Designed for RS-485 interface application
- - 7 V to 12 V common mode input voltage range
- Driver maintains high impedance in 3-state or with the power OFF
- 70 mV typical input hysteresis
- 30 ns propagation delay, 5 ns skew
- Operate from a single 5 V supply
- Current limiting and thermal shutdown for driver overload protection
- Allows up to 64 transceivers on the bus

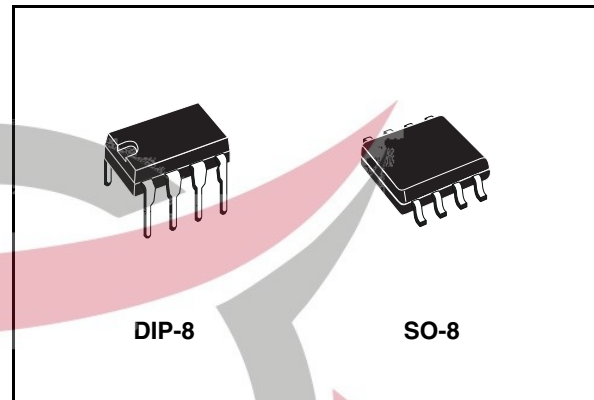

The ST485 is available in three temperature range: commercial (0 °C to 70 °C), industrial (- 40 °C to 85 °C) and automotive (- 55 °C to 125 °C).

### Description

The ST485 is a low power transceiver for RS-485 and RS-422 communication. Each part contains one driver and one receiver.

This transceiver draws 300  $\mu$ A (typ.) of supply current when unloaded or fully loaded with disabled drivers.

It operates from a single 5 V supply.

Driver is short-circuit current limited and is protected against excessive power dissipation by thermal shutdown circuitry that places the driver outputs into a high-impedance state.

The ST485 is designed for bi-directional data communications on multipoint bus transmission line (half-duplex applications).

**Table 1. Device summary**

Order code	Temperature range	Package	Packaging
ST485CN	0 to 70 °C	DIP-8	50 parts per tube / 40 tube per box
ST485BN	- 40 to 85 °C	DIP-8	50 parts per tube / 40 tube per box
ST485CDR	0 to 70 °C	SO-8 (tape and reel)	2500 parts per reel
ST485BDR	- 40 to 85 °C	SO-8 (tape and reel)	2500 parts per reel

# Contents

<b>1</b>	<b>Pin configuration</b> .....	<b>3</b>
1.1	Pin description .....	3
<b>2</b>	<b>Truth tables</b> .....	<b>4</b>
<b>3</b>	<b>Maximum ratings</b> .....	<b>5</b>
<b>4</b>	<b>Electrical characteristics</b> .....	<b>6</b>
4.1	Driver switching characteristics .....	7
4.2	Receiver switching characteristics .....	8
<b>5</b>	<b>Test circuit and typical characteristics</b> .....	<b>9</b>
<b>6</b>	<b>Package mechanical data</b> .....	<b>14</b>
<b>7</b>	<b>Revision history</b> .....	<b>18</b>



**SKYTECH**  
ELECTRONIC

# 1 Pin configuration

Figure 1. Pin connections

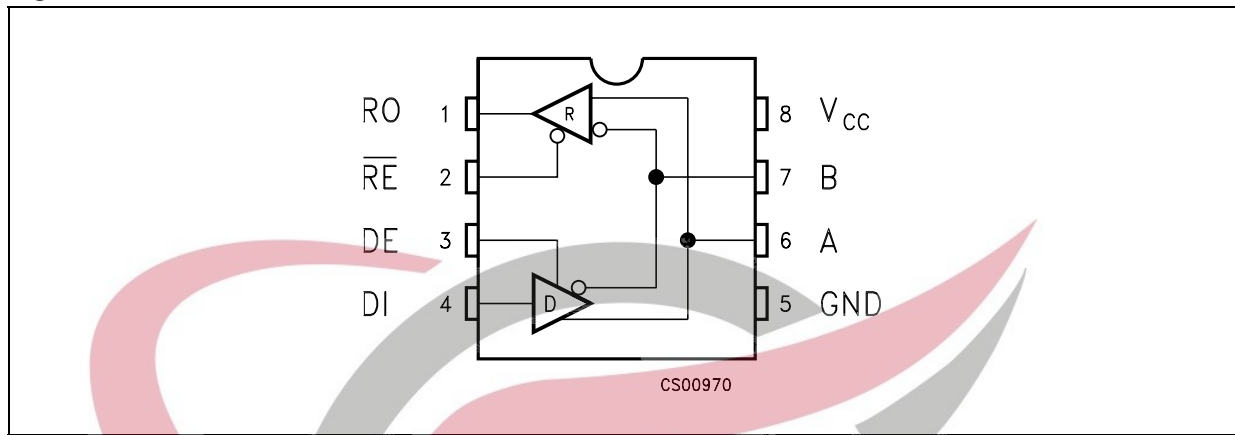

Table 2. Pin description

Pin n°	Symbol	Name and function
1	RO	Receiver output
2	RE	Receiver output enable
3	DE	Driver output enable
4	DI	Driver input
5	GND	Ground
6	A	Non-inverting receiver input and non-inverting driver output
7	B	Inverting receiver input and inverting driver output
8	V <sub>CC</sub>	Supply voltage

**SKYTECH**  
ELECTRONIC

## 2 Truth tables

**Table 3. Truth table (driver)**

Inputs			Outputs	
RE	DE	DI	B	A
X	H	H	L	H
X	H	L	H	L
X	L	X	Z	Z

Note: X = Don't care; Z = High impedance

**Table 4. Truth table (receiver)**

Inputs			Outputs
RE	DE	A-B	RO
L	L	$\geq +0.2V$	H
L	L	$\leq -0.2V$	L
L	L	Inputs open	H
H	L	X	Z

Note: X = Don't care; Z = High impedance



### 3 Maximum ratings

**Table 5. Absolute maximum ratings**

Symbol	Parameter	Value	Unit
$V_{CC}$	Supply voltage	7	V
$V_I$	Control input voltage ( $\overline{RE}$ , DE)	-0.5 to ( $V_{CC} + 0.5$ )	V
$V_{DI}$	Driver input voltage (DI)	-0.5 to ( $V_{CC} + 0.5$ )	V
$V_{DO}$	Driver output voltage (A, B)	$\pm 14$	V
$V_{RI}$	Receiver input voltage (A, B)	$\pm 14$	V
$V_{RO}$	Receiver output voltage (RO)	-0.5 to ( $V_{CC} + 0.5$ )	V

*Note: Absolute maximum ratings are those values beyond which damage to the device may occur. Functional operation under these condition is not implied.*



**SKYTECH**  
ELECTRONIC

## 4 Electrical characteristics

$V_{CC} = 5\text{ V} \pm 5\%$ ,  $T_A = T_{MIN}$  to  $T_{MAX}$ , unless otherwise specified. Typical values are referred to  $T_A = 25\text{ }^\circ\text{C}$

**Table 6. DC electrical characteristics**

Symbol	Parameter	Test conditions <sup>(1)</sup>	Value					Unit
			-40 to 85 °C			-55 to 125 °C		
			Min.	Typ.	Max.	Min.	Max.	
$V_{OD1}$	Differential driver output (no load)				5		5	V
$V_{OD2}$	Differential driver output (with load)	$R_L = 27\Omega$ (RS-485) <i>Figure 2</i> $R_L = 50\Omega$ (RS-422) <i>Figure 2</i>	1.5		5 5	1.4	5 5	V V
$\Delta V_{OD}$	Change in magnitude of driver differential output voltage for complementary output states	$R_L = 27\Omega$ or $50\Omega$ <i>Figure 2</i>			0.2		0.2	V
$V_{OC}$	Driver common-mode output voltage	$R_L = 27\Omega$ or $50\Omega$ <i>Figure 2</i>			3		3	V
$\Delta V_{OC}$	Change in magnitude of driver common-mode output voltage for complementary output states	$R_L = 27\Omega$ or $50\Omega$ <i>Figure 2</i>			0.2		0.2	V
$V_{IH}$	Input high voltage	$\overline{RE}$ , DE, DI	2.0			2.0		V
$V_{IL}$	Input low voltage	$\overline{RE}$ , DE, DI			0.8		0.8	V
$I_{IN1}$	Input current	$\overline{RE}$ , DE, DI			$\pm 2$		$\pm 2$	$\mu\text{A}$
$I_{IN2}$	Input current (A, B)	$V_{CM} = 0\text{V}$ or $5.25\text{V}$ , $V_{DE} = 0\text{V}$ $V_{IN} = 12\text{V}$ $V_{IN} = -7\text{V}$			1 -0.8		1 -0.8	mA mA
$V_{TH}$	Receiver differential threshold voltage	$V_{CM} = -7$ to $12\text{V}$	-0.2		0.2	-0.2	0.2	V
$\Delta V_{TH}$	Receiver input hysteresis	$V_{CM} = 0\text{V}$		70				mV
$V_{OH}$	Receiver output high voltage	$I_O = -4\text{mA}$ , $V_{ID} = 200\text{mV}$	3.5			3.4		V
$V_{OL}$	Receiver output low voltage	$I_O = 4\text{mA}$ , $V_{ID} = -200\text{mV}$			0.4		0.55	V
$I_{OZR}$	3-state (high impedance) output current at receiver	$V_O = 0.4$ to $2.4\text{V}$			$\pm 1$		$\pm 1$	$\mu\text{A}$
$R_{IN}$	Receiver input resistance	$V_{CM} = -7$ to $12\text{V}$	24			24		$\text{k}\Omega$
$I_{CC}$	No load supply current <sup>(2)</sup>	$V_{RE} = 0\text{V}$ or $V_{CC}$ $V_{DE} = V_{CC}$ $V_{DE} = 0\text{V}$		400 300	900 500		900 500	$\mu\text{A}$ $\mu\text{A}$

Table 6. DC electrical characteristics (continued)

Symbol	Parameter	Test conditions <sup>(1)</sup>	Value					Unit
			-40 to 85 °C			-55 to 125 °C		
			Min.	Typ.	Max.	Min.	Max.	
I <sub>OSD1</sub>	Driver short-circuit current, V <sub>O</sub> =High	V <sub>O</sub> = -7 to 12V <sup>(3)</sup>	35		250	35	250	mA
I <sub>OSD2</sub>	Driver short-circuit current, V <sub>O</sub> =Low	V <sub>O</sub> = -7 to 12V <sup>(3)</sup>	35		250	35	250	mA
I <sub>OSR</sub>	Receiver short-circuit current	V <sub>O</sub> = 0V to V <sub>CC</sub>	7		95	7	95	mA

1. All currents into device pins are positive; all currents out of device pins are negative; all voltages are referenced to device ground unless specified.
2. Supply current specification is valid for loaded transmitters when V<sub>DE</sub> = 0V
3. Applies to peak current. See typical Operating Characteristics.

V<sub>CC</sub> = 5 V ± 5 %, T<sub>A</sub> = T<sub>MIN</sub> to T<sub>MAX</sub>, unless otherwise specified. Typical values are referred to T<sub>A</sub> = 25 °C

Table 7. Driver switching characteristics

Symbol	Parameter	Test conditions <sup>(1)</sup>	Value					Unit
			-40 to 85 °C			-55 to 125 °C		
			Min.	Typ.	Max.	Min.	Max.	
t <sub>PLH</sub> t <sub>PHL</sub>	Propagation delay input to output	R <sub>DIFF</sub> = 54Ω, C <sub>L1</sub> = C <sub>L2</sub> = 100pF (See <a href="#">Figure 4</a> and <a href="#">Figure 6</a> )	10	30	60		70	ns
t <sub>SK</sub>	Output skew to output	R <sub>DIFF</sub> = 54Ω, C <sub>L1</sub> = C <sub>L2</sub> = 100pF (See <a href="#">Figure 4</a> and <a href="#">Figure 6</a> )		5	10		10	ns
t <sub>TLH</sub> t <sub>THL</sub>	Rise or fall time	R <sub>DIFF</sub> = 54Ω, C <sub>L1</sub> = C <sub>L2</sub> = 100pF (See <a href="#">Figure 4</a> and <a href="#">Figure 6</a> )	3	15	40	3	45	ns
t <sub>PZH</sub>	Output enable time	C <sub>L</sub> = 100pF, S2 = Closed (See <a href="#">Figure 5</a> and <a href="#">Figure 7</a> )		70	90		90	ns
t <sub>PZL</sub>	Output enable time	C <sub>L</sub> = 100pF, S1 = Closed (See <a href="#">Figure 5</a> and <a href="#">Figure 7</a> )		70	90		90	ns
t <sub>PLZ</sub>	Output disable time	C <sub>L</sub> = 15pF, S1 = Closed (See <a href="#">Figure 5</a> and <a href="#">Figure 7</a> )		70	90		90	ns
t <sub>PHZ</sub>	Output disable time	C <sub>L</sub> = 15pF, S2 = Closed (See <a href="#">Figure 5</a> and <a href="#">Figure 7</a> )		70	90		90	ns

1. All currents into device pins are positive; all currents out of device pins are negative; all voltages are referenced to device ground unless specified.

$V_{CC} = 5\text{ V} \pm 5\%$ ,  $T_A = T_{MIN}$  to  $T_{MAX}$ , unless otherwise specified. Typical values are referred to  $T_A = 25\text{ }^\circ\text{C}$

**Table 8. Receiver switching characteristics**

Symbol	Parameter	Test conditions <sup>(1)</sup>	Value					Unit
			-40 to 85 °C			-55 to 125°C		
			Min.	Typ.	Max.	Min.	Max.	
$t_{PLH}$ $t_{PHL}$	Propagation delay input to output	$R_{DIFF}=54\Omega$ , $C_{L1} = C_{L2} = 100\text{pF}$ (See <a href="#">Figure 4</a> and <a href="#">Figure 8</a> )	20	130	210		230	ns
$t_{SKD}$	Differential receiver skew	$R_{DIFF}=54\Omega$ , $C_{L1} = C_{L2} = 100\text{pF}$ (See <a href="#">Figure 4</a> and <a href="#">Figure 8</a> )		13				ns
$t_{PZH}$	Output enable time	$C_{RL} = 15\text{pF}$ , S1 = Closed (See Fig. 2 and <a href="#">Figure 9</a> )		20	50		56	ns
$t_{PZL}$	Output enable time	$C_{RL} = 15\text{pF}$ , S2 = Closed (See Fig. 2 and <a href="#">Figure 9</a> )		20	50		56	ns
$t_{PLZ}$	Output disable time	$C_{RL} = 15\text{pF}$ , S1 = Closed (See Fig. 2 and <a href="#">Figure 9</a> )		20	50		56	ns
$t_{PHZ}$	Output disable time	$C_{RL} = 15\text{pF}$ , S2 = Closed (See Fig. 2 and <a href="#">Figure 9</a> )		20	50		56	ns
$f_{MAX}$	Maximum data rate		2.5			2.5		Mbps

1. All currents into device pins are positive; all currents out of device pins are negative; all voltages are referenced to device ground unless specified

**SKYTECH**  
ELECTRONIC



## 5 Test circuit and typical characteristics

Figure 2. Driver DC test load

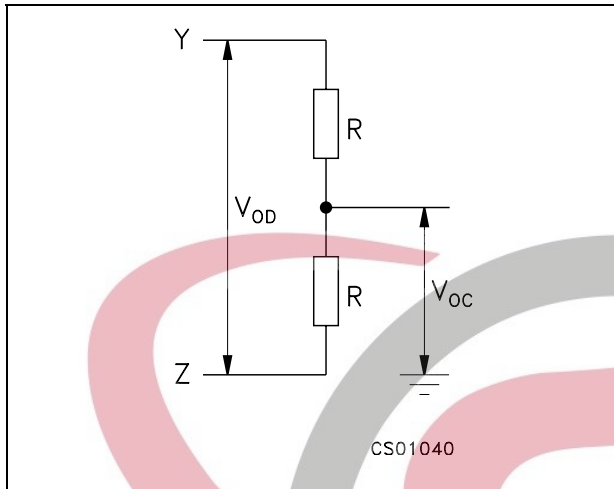

Figure 3. Receiver timing test load

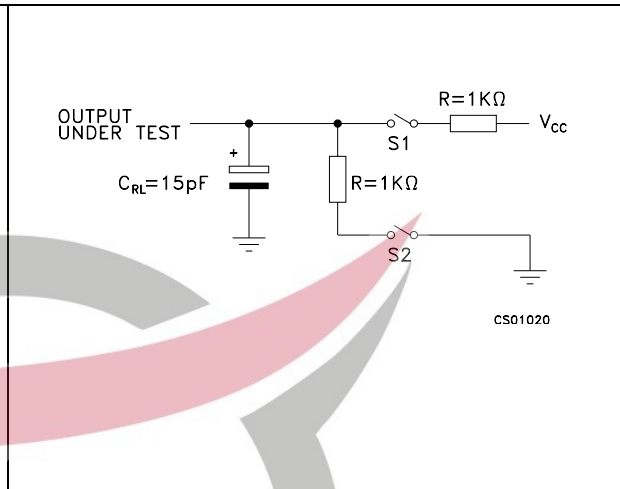

Figure 4. Drive/receiver timing test circuit

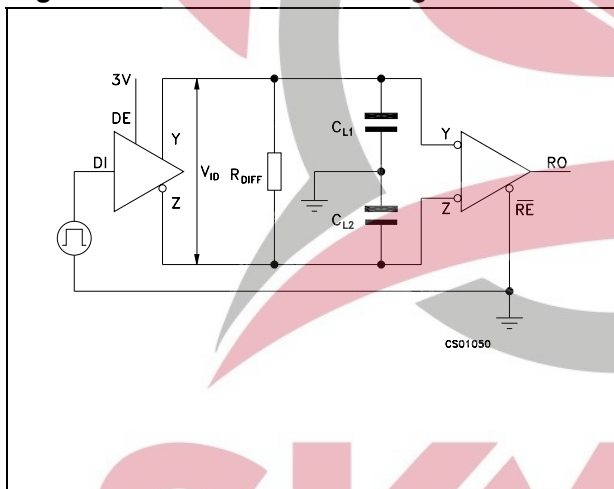

Figure 5. Driver timing test load

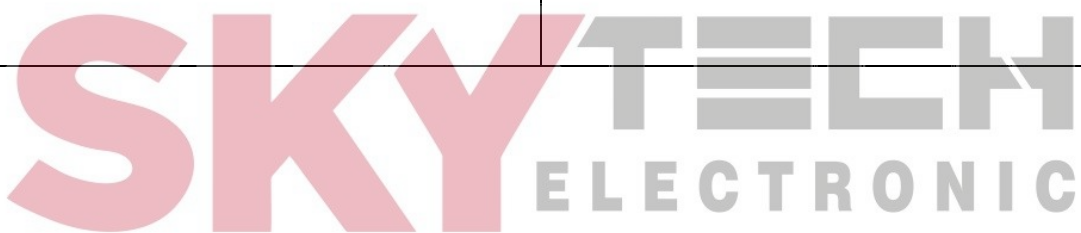
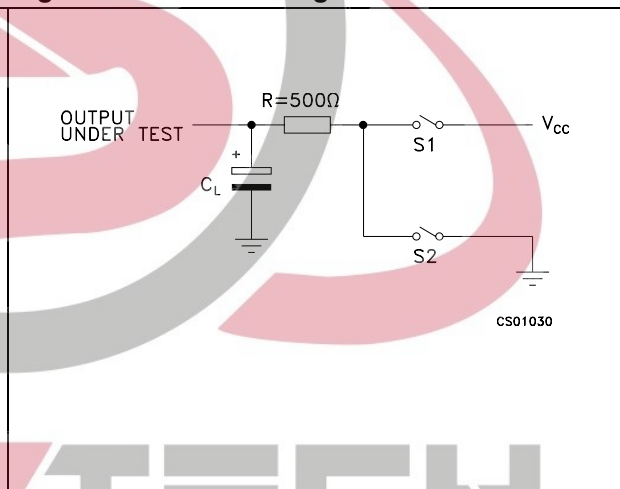

Figure 6. Driver propagation delay

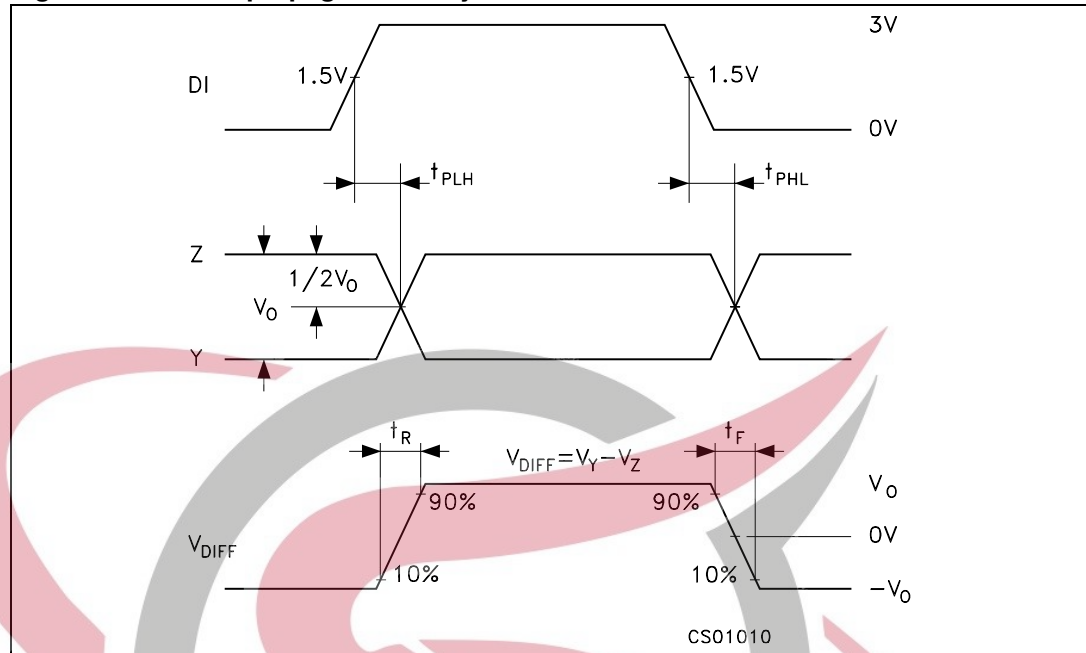

Figure 7. Driver enable and disable time

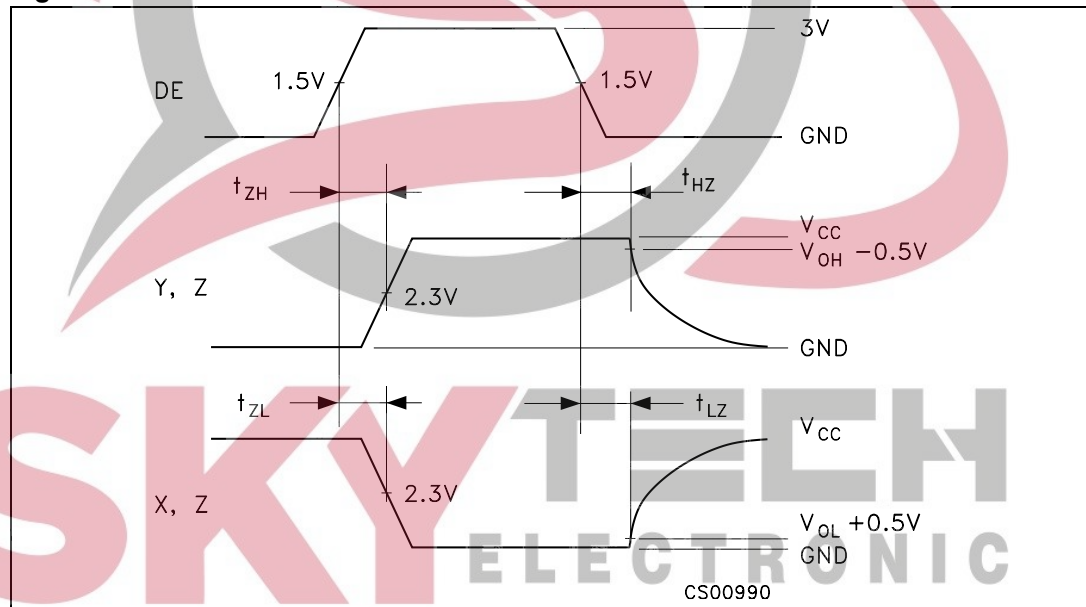

Figure 8. Receiver propagation delay

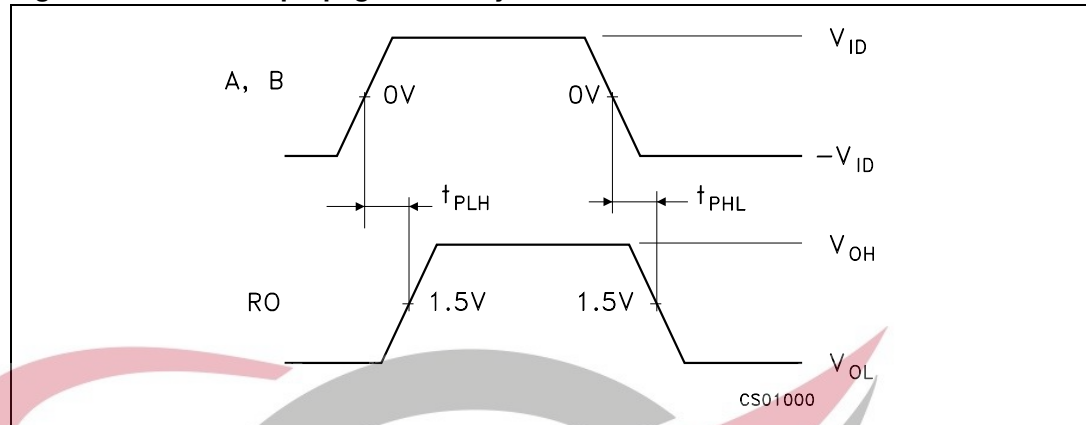
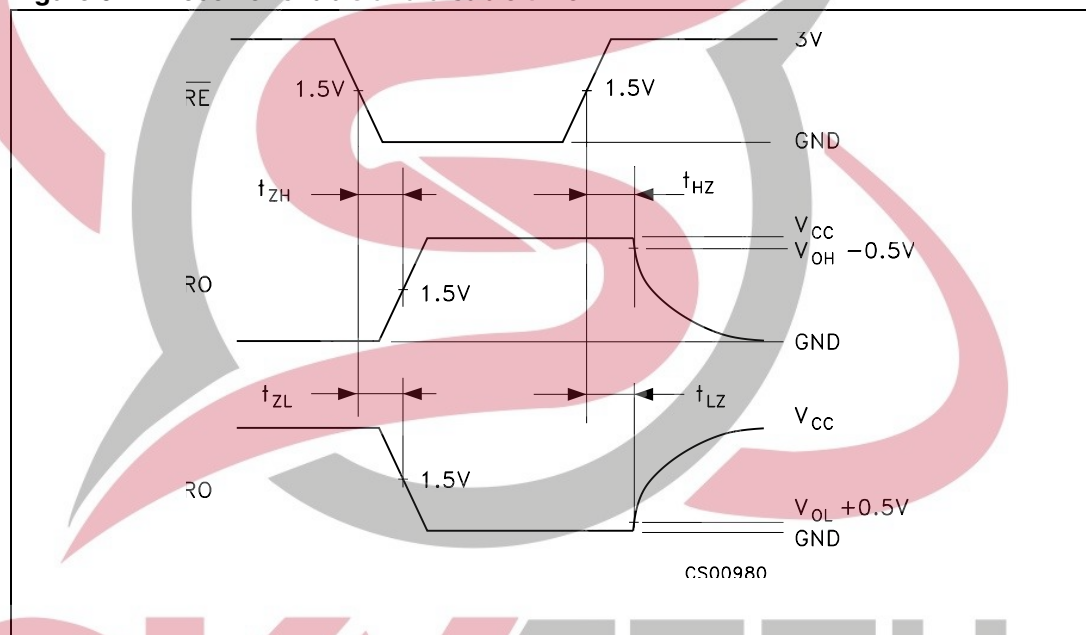

Figure 9. Receiver enable and disable time



SKYTECH  
ELECTRONIC

Figure 10. Receiver output current vs. output low voltage

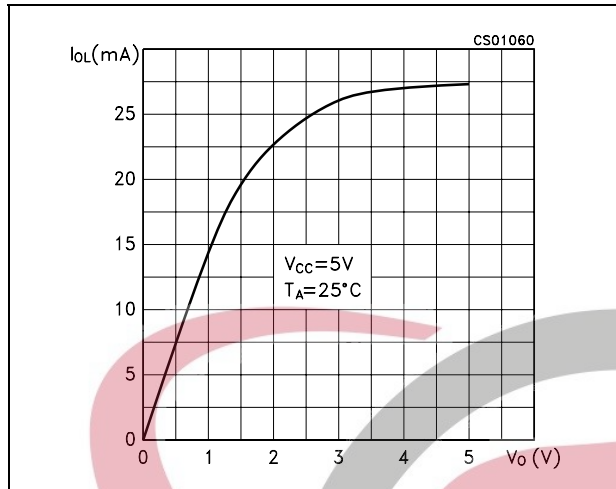

Figure 11. Receiver output current vs. output high voltage

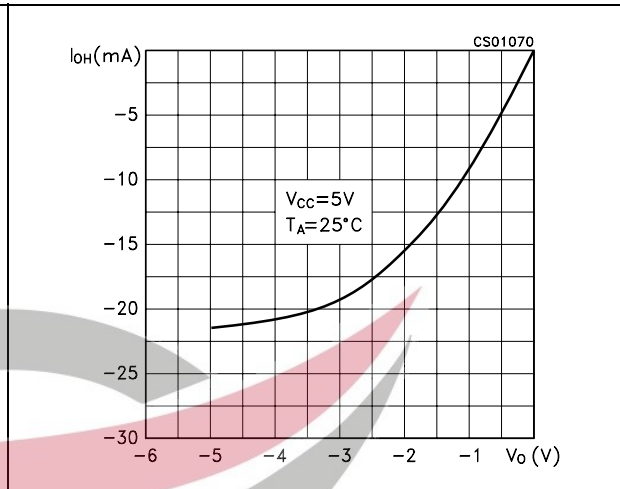

Figure 12. Driver output current vs. output low voltage

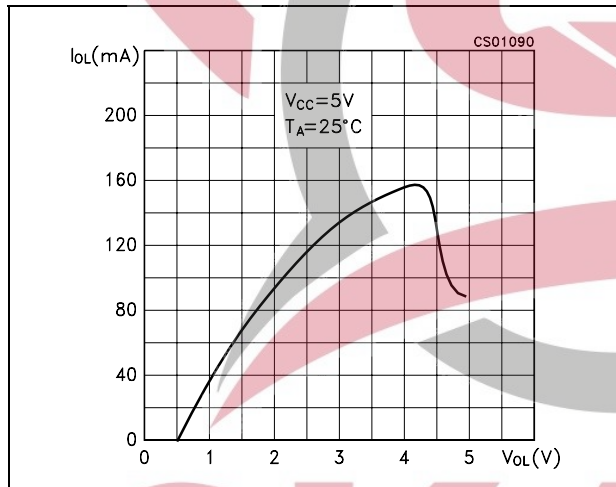

Figure 13. Driver output current vs. output high voltage

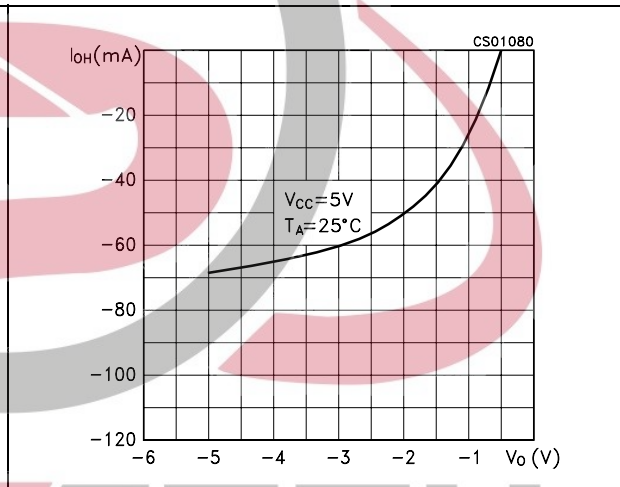

Figure 14. Supply current vs. temperature

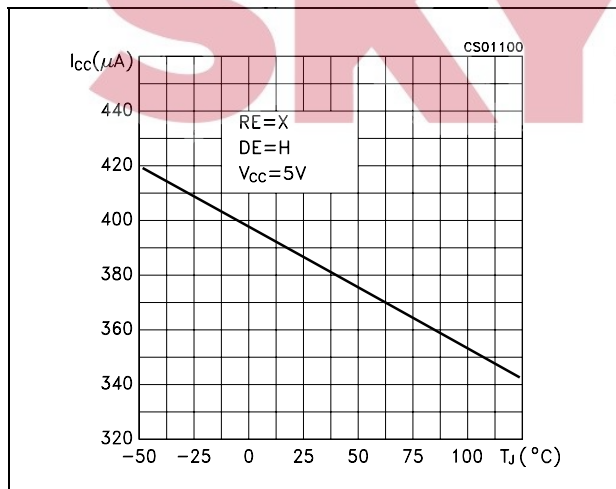

Figure 15. Receiver high level output voltage vs. temperature

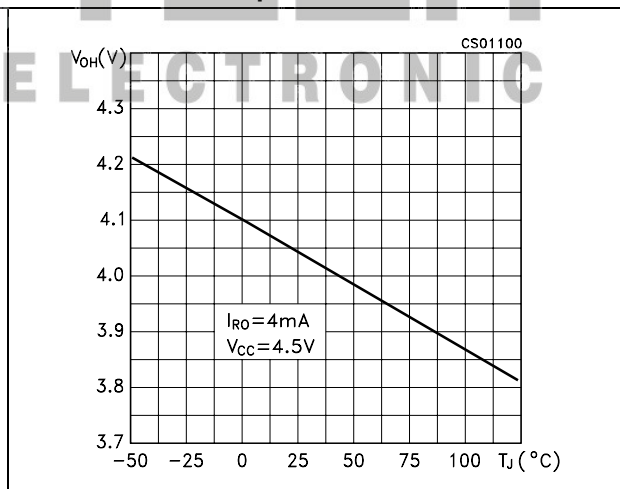

Figure 16. Receiver low level output voltage vs. temperature

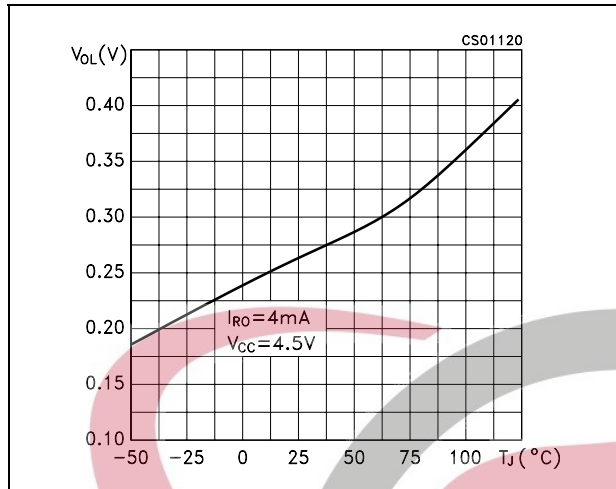
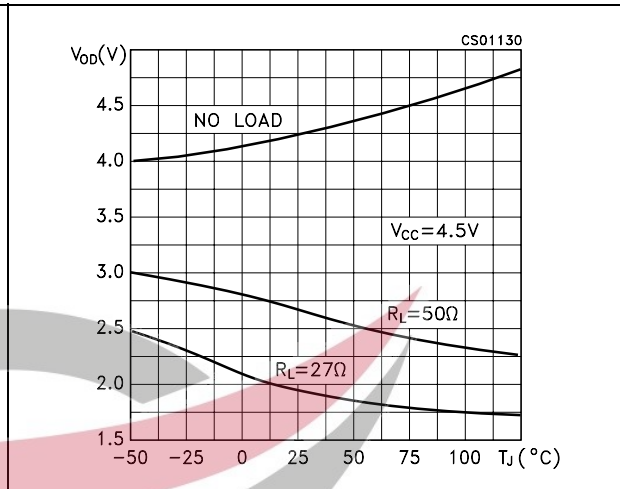

Figure 17. Differential driver output voltage vs. temperature



## 6 Package mechanical data

In order to meet environmental requirements, ST offers these devices in different grades of ECOPACK® packages, depending on their level of environmental compliance. ECOPACK® specifications, grade definitions and product status are available at: [www.st.com](http://www.st.com). ECOPACK is an ST trademark.



**Plastic DIP-8 mechanical data**

Dim.	mm.			inch.		
	Min.	Typ.	Max.	Min.	Typ.	Max.
A		3.3			0.130	
a1	0.7			0.028		
B	1.39		1.65	0.055		0.065
B1	0.91		1.04	0.036		0.041
b		0.5			0.020	
b1	0.38		0.5	0.015		0.020
D			9.8			0.386
E		8.8			0.346	
e		2.54			0.100	
e3		7.62			0.300	
e4		7.62			0.300	
F			7.1			0.280
l			4.8			0.189
L		3.3			0.130	
Z	0.44		1.6	0.017		0.063

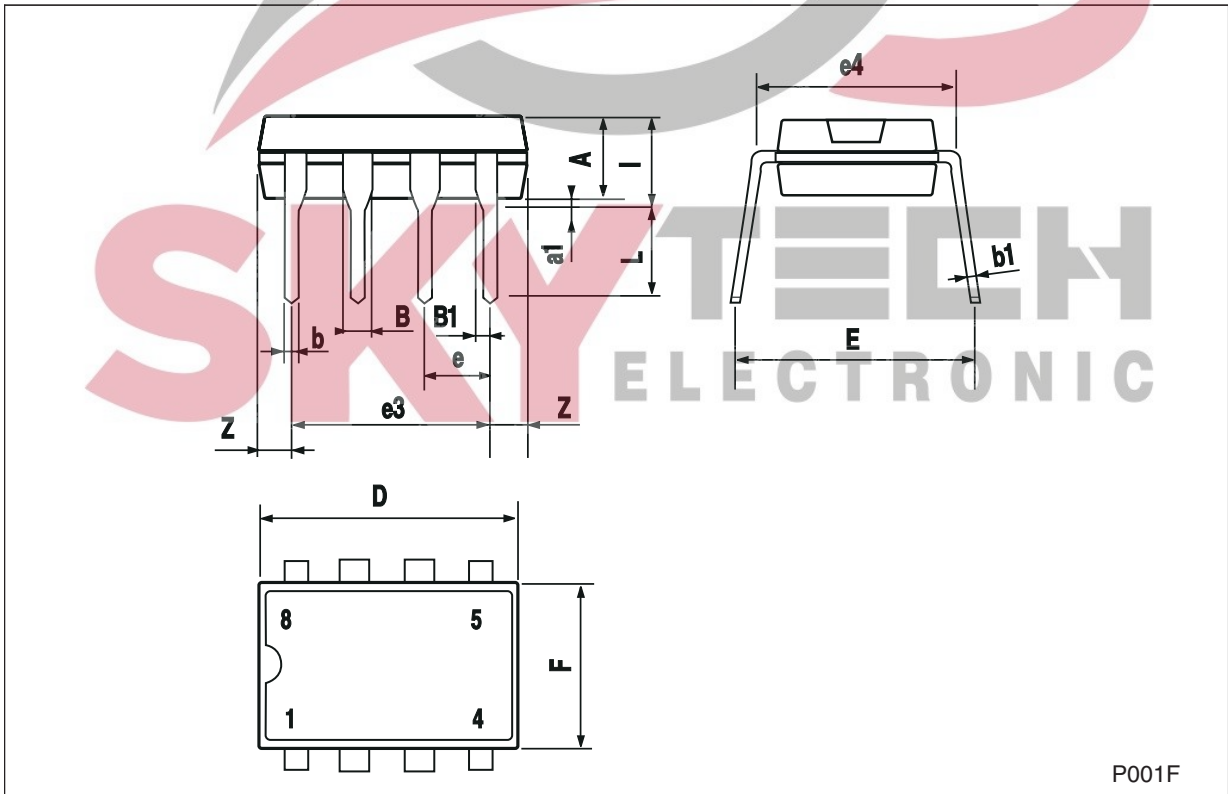

P001F



**SO-8 mechanical data**

Dim.	mm.			inch.		
	Min.	Typ.	Max.	Min.	Typ.	Max.
A	1.35		1.75	0.053		0.069
A1	0.10		0.25	0.04		0.010
A2	1.10		1.65	0.043		0.065
B	0.33		0.51	0.013		0.020
C	0.19		0.25	0.007		0.010
D	4.80		5.00	0.189		0.197
E	3.80		4.00	0.150		0.157
e		1.27			0.050	
H	5.80		6.20	0.228		0.244
h	0.25		0.50	0.010		0.020
L	0.40		1.27	0.016		0.050
k	8° (max.)					
ddd			0.1			0.04

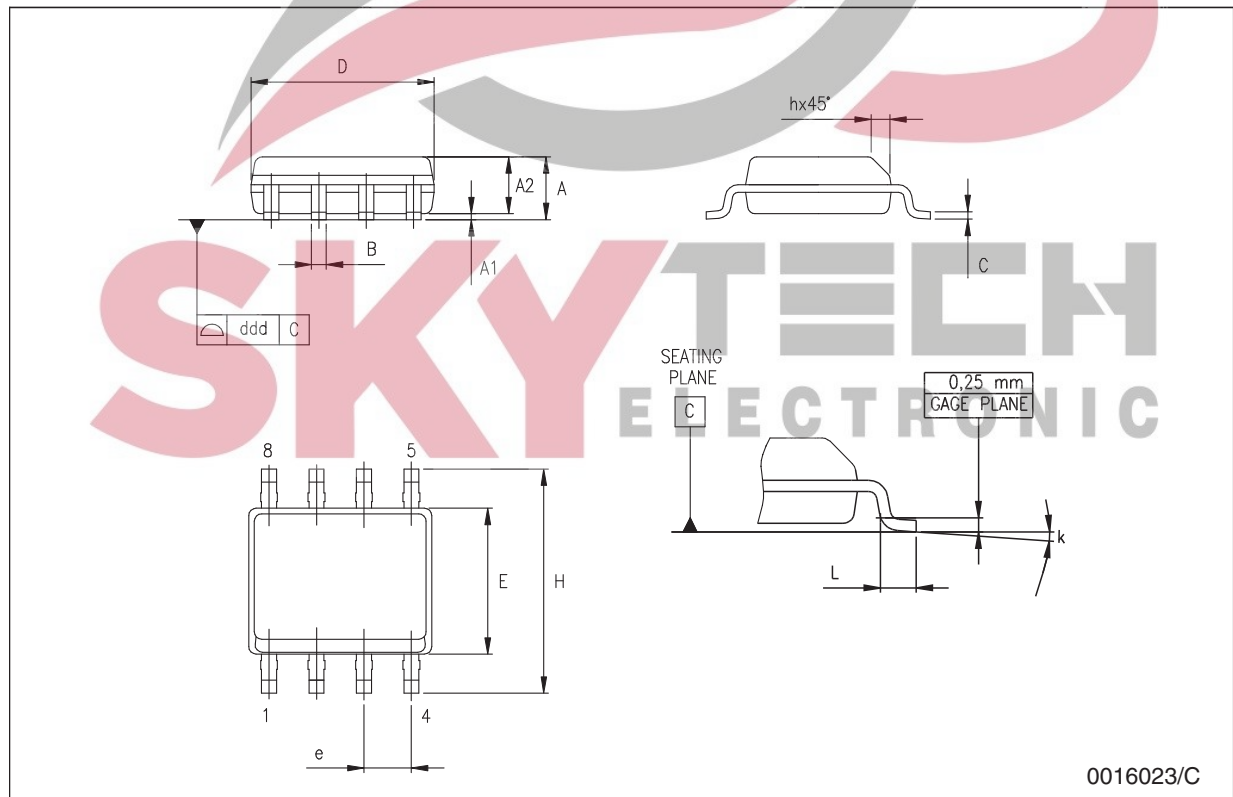

0016023/C



**Tape & reel SO-8 mechanical data**

Dim.	mm.			inch.		
	Min.	Typ.	Max.	Min.	Typ.	Max.
A			330			12.992
C	12.8		13.2	0.504		0.519
D	20.2			0.795		
N	60			2.362		
T			22.4			0.882
Ao	8.1		8.5	0.319		0.335
Bo	5.5		5.9	0.216		0.232
Ko	2.1		2.3	0.082		0.090
Po	3.9		4.1	0.153		0.161
P	7.9		8.1	0.311		0.319

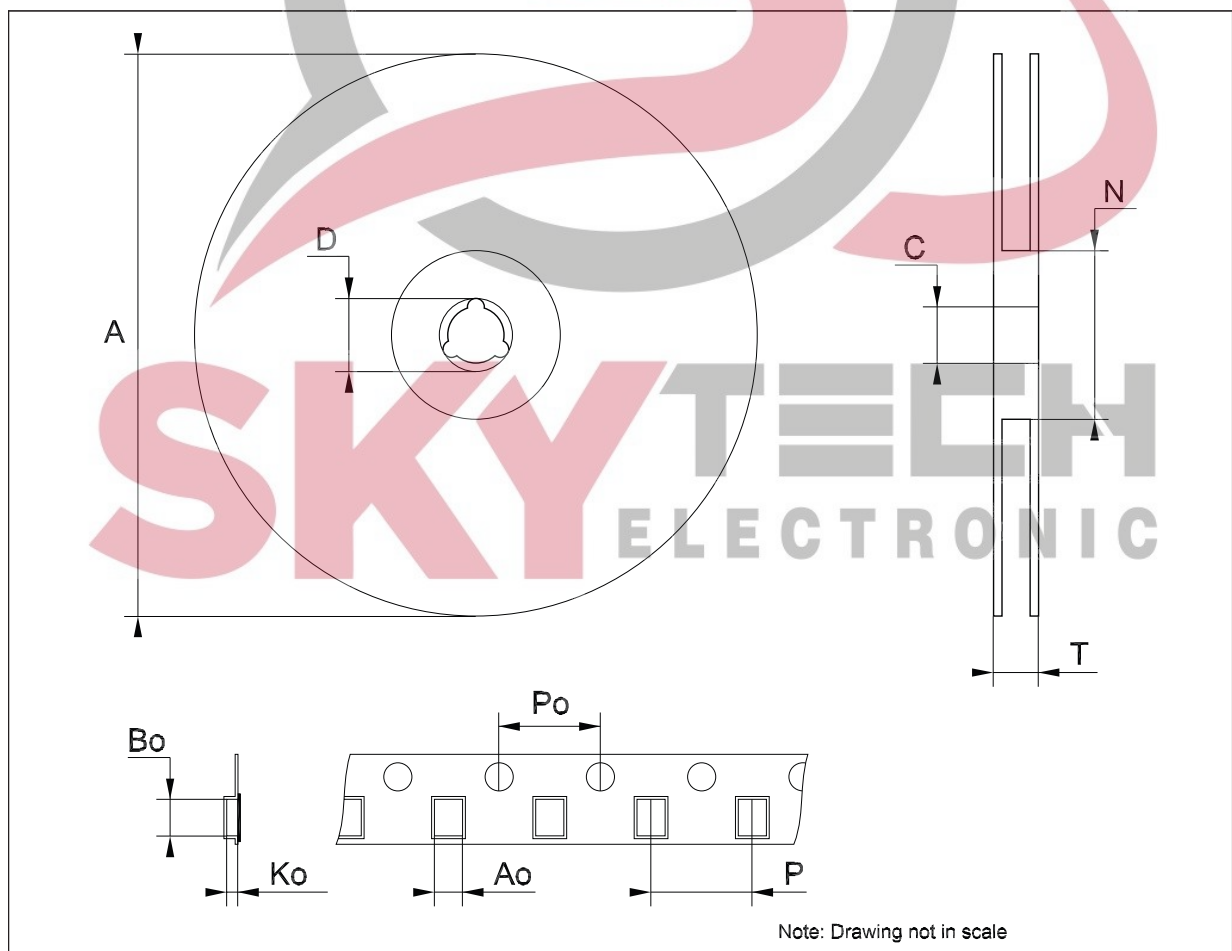

## 7 Revision history

Table 9. Document revision history

Date	Revision	Changes
21-Mar-2006	12	Order codes has been updated and new template.
02-Aug-2006	13	Mistake in cover page first row mA ==> $\mu$ A.
08-Nov-2006	14	Added: <a href="#">Table 1</a> .
07-Feb-2008	15	Modified: <a href="#">Table 1 on page 1</a> .
16-Feb-2009	16	Modified <a href="#">Note: on page 5</a> .



**Please Read Carefully:**

Information in this document is provided solely in connection with ST products. STMicroelectronics NV and its subsidiaries ("ST") reserve the right to make changes, corrections, modifications or improvements, to this document, and the products and services described herein at any time, without notice.

All ST products are sold pursuant to ST's terms and conditions of sale.

Purchasers are solely responsible for the choice, selection and use of the ST products and services described herein, and ST assumes no liability whatsoever relating to the choice, selection or use of the ST products and services described herein.

No license, express or implied, by estoppel or otherwise, to any intellectual property rights is granted under this document. If any part of this document refers to any third party products or services it shall not be deemed a license grant by ST for the use of such third party products or services, or any intellectual property contained therein or considered as a warranty covering the use in any manner whatsoever of such third party products or services or any intellectual property contained therein.

**UNLESS OTHERWISE SET FORTH IN ST'S TERMS AND CONDITIONS OF SALE ST DISCLAIMS ANY EXPRESS OR IMPLIED WARRANTY WITH RESPECT TO THE USE AND/OR SALE OF ST PRODUCTS INCLUDING WITHOUT LIMITATION IMPLIED WARRANTIES OF MERCHANTABILITY, FITNESS FOR A PARTICULAR PURPOSE (AND THEIR EQUIVALENTS UNDER THE LAWS OF ANY JURISDICTION), OR INFRINGEMENT OF ANY PATENT, COPYRIGHT OR OTHER INTELLECTUAL PROPERTY RIGHT.**

**UNLESS EXPRESSLY APPROVED IN WRITING BY AN AUTHORIZED ST REPRESENTATIVE, ST PRODUCTS ARE NOT RECOMMENDED, AUTHORIZED OR WARRANTED FOR USE IN MILITARY, AIR CRAFT, SPACE, LIFE SAVING, OR LIFE SUSTAINING APPLICATIONS, NOR IN PRODUCTS OR SYSTEMS WHERE FAILURE OR MALFUNCTION MAY RESULT IN PERSONAL INJURY, DEATH, OR SEVERE PROPERTY OR ENVIRONMENTAL DAMAGE. ST PRODUCTS WHICH ARE NOT SPECIFIED AS "AUTOMOTIVE GRADE" MAY ONLY BE USED IN AUTOMOTIVE APPLICATIONS AT USER'S OWN RISK.**

Resale of ST products with provisions different from the statements and/or technical features set forth in this document shall immediately void any warranty granted by ST for the ST product or service described herein and shall not create or extend in any manner whatsoever, any liability of ST.

ST and the ST logo are trademarks or registered trademarks of ST in various countries.

Information in this document supersedes and replaces all information previously supplied.

The ST logo is a registered trademark of STMicroelectronics. All other names are the property of their respective owners.

© 2009 STMicroelectronics - All rights reserved

STMicroelectronics group of companies

Australia - Belgium - Brazil - Canada - China - Czech Republic - Finland - France - Germany - Hong Kong - India - Israel - Italy - Japan - Malaysia - Malta - Morocco - Singapore - Spain - Sweden - Switzerland - United Kingdom - United States of America

[www.st.com](http://www.st.com)

